



Please be sure to visit [altronix.com](http://altronix.com) for latest firmware and installation instructions

Fiber Solution

# NetWaySP4BT Series

4-port Hardened 802.3bt  
4PPoE Switches (Layer 2)

## Models Include:

### NetWaySP4BTWP

- 4-port Hardened 802.3bt 4PPoE Switch and Power Supply/Charger
- NEMA4/4X, IP66 rated Outdoor enclosure.

### NetWaySP4BTWPX

- 4-port Hardened 802.3bt 4PPoE Switch and Power Supply/Charger
- NEMA4/4X, IP66 rated Outdoor enclosure.
- Accommodates up to four (4) 12VDC/4AH batteries.

### NetWaySP4BTWPN

- 4-port Hardened 802.3bt 4PPoE Switch (uses external power supply).
- NEMA4/4X, IP66 rated Outdoor enclosure.

### NetWaySP4BTX

- 4-port Hardened 802.3bt 4PPoE Switch and Power Supply/Charger
- NEMA1 rated Indoor enclosure.

### NetWaySP4BTPL

- 4-port Hardened 802.3bt 4PPoE Switch and Power Supply/Charger
- Backplane version.

### NetWaySP4BTB

- 4-port Hardened 802.3bt 4PPoE Switch
- Board Only.

## Installation Guide



DOC#: NetWaySP4BT Rev. 120920

More than just power.™

Installing Company: \_\_\_\_\_ Service Rep. Name: \_\_\_\_\_

Address: \_\_\_\_\_ Phone #: \_\_\_\_\_

## Overview:

Altronix NetWaySP4BT Series Hardened 802.3bt 4PPoE Layer 2 Switches are equipped with two (2) 1Gb SFP ports and four (4) 802.3bt compliant Ethernet ports rated at 90W each, limited to 240W total power. Embedded LINQ Technology enables monitoring, control, and reporting from anywhere over the network.

## Features:

### Agency Listings:

- CE European Conformity.

### Input

- NetWaySP4BTWP/NetWaySP4BTWPX/  
NetWaySP4BTPL/ NetWaySP4BTX:  
115VAC, 60Hz, 1.8A or 230VAC, 50/60Hz, 1A.
- NetWaySP4BTB/NetWaySP4BTWPN:  
48-56V UL Listed ITE power supply.

### Output

- NetWaySP4BTWP/NetWaySP4BTWPX/  
NetWaySP4BTPL/ NetWaySP4BTX:  
Four (4) 10/100/1000 Mbps Ethernet ports rated at 90W each (limited to 240W total power).
- NetWaySP4BTB/NetWaySP4BTWPN:  
Four (4) 10/100/1000 Mbps Ethernet ports rated at 90W each (depending on the power supply employed, limited to 320W total power).
- IEEE 802.3af, 802.3at, 802.3bt compliant.

### SFP Ports:

- Two (2) Gigabit SFP ports.

### Ethernet Ports:

- Four (4) 10/100/1000 Mbps ports.
- Connectivity: RJ45, auto-crossover.
- Wire type: 4-pair CAT5e or higher structured cable.
- Speed: 10/100/1000 Mbps, half/full duplex, auto negotiation.

### VLAN:

- Multiple management VLAN assignment.
- 802.1Q Tagged VLAN.
- Up to 10 VLAN groups. ID Range 2-4095.

### Battery Backup:

- NetWaySP4BTWP/NetWaySP4BTWPX/  
NetWaySP4BTPL/ NetWaySP4BTX:  
24VDC charging circuit charges  
LiFePO<sub>4</sub> (Lithium Iron Phosphate) or  
sealed lead acid\* or gel type\* batteries.
- Automatic switch over to stand-by battery  
when AC fails.

### Indicators (LED)

- Individual PoE On LEDs for each port.
- Individual IP Link status, 10/100/1000  
Base-T/active LEDs for each port.
- ALOS LED indicates fiber connection for SFP port.
- Heartbeat LED indicates proper operation of the unit.

### LINQ Technology:

- Remote network management allows for camera/  
device reset and diagnostic monitoring.
- Provides local and/or remote access to critical  
information via LAN/WAN.
- Email and Windows Dashboard Alert notifications  
report real-time events.
- Event log tracks history.

### Mechanical:

#### NetWaySP4BTB:

- Dimensions (L x W x D approx.):  
6.5" x 4.5" x 0.625"  
(165.1mm x 142.9mm x 15.9mm).

#### NetWaySP4BTPL:

- Dimensions (H x W x D approx.):  
10.75" x 8.875" x 2.375"  
(273.1mm x 225.4mm x 60.3mm).

#### NetWaySP4BTWP, NetWaySP4BTWPN:

- NEMA4/4X, IP66 Rated enclosure for outdoor use.
- Dimensions (H x W x D approx.):  
13.31" x 11.31" x 5.59"  
(338.1mm x 287.3mm x 142mm).

#### NetWaySP4BTWPX:

- NEMA4/4X, IP66 Rated enclosure for outdoor use.
- Accommodates sealed lead acid or gel type  
or LiFePO<sub>4</sub> (Lithium Iron Phosphate) 12VDC batteries.
- Dimensions (H x W x D approx.):  
17.53" x 15.3" x 6.67"  
(445.3mm x 388.6mm x 169.4mm).

#### NetWaySP4BTX:

- NEMA1 rated indoor enclosure
- Dimensions (H x W x D approx.):  
13.5" x 13" x 3.25" (342.9mm x 330.2mm x 83mm).

\***CAUTION:** When using lead acid or gel type batteries, enclosure must be properly ventilated.

## **Recommended Altronix Power Sourcing Equipment:**

<b>NetWaySP4P</b>	Ethernet to Fiber Media Converter with Integral Power Supply/Charger. Four (4) 56VDC non power-limited outputs up to 120W max. full power per port (240W total power). Four (4) 1Gb SFP ports.
<b>NetWaySP4PX</b>	Ethernet to Fiber Media Converter with Integral Power Supply/Charger. Four (4) 56VDC non power-limited outputs up to 120W max. full power per port (480W total power). Four (4) 1Gb SFP ports.
<b>NetWaySP4P2</b>	Ethernet to Fiber Media Converter with Integral Power-Limited Power Supply/Charger. Four (4) 56VDC power-limited outputs up to 60W max. full power per port (240W total power). Four (4) 1Gb SFP ports.
<b>WayPoint562</b>	High Current Outdoor Power Supply/Charger. 56VDC/120W output. Filtered and electronically regulated output. Short circuit and thermal overload protection.
<b>Vertiline563</b>	EIA 19" 1U Rack Mountable Dual Independent Power Supply/Charger. 56VDC @ 3A each output. Filtered and electronically regulated output. Short circuit and thermal overload protection.
<b>PoE240</b>	Power Supply/Charger Board. 56VD/240W output. Filtered and electronically regulated output. Short circuit and thermal overload protection.

## **Recommended Altronix SFP Modules:**

Altronix P1MM, P1SM10, P1AB2K and P1GCE are hot-pluggable SFP fiber transceiver modules and are readily usable with all Altronix Spectrum fiber optic equipment for 1Gb transmission rates.

<b>P1MM</b>	For use with Multi-Mode Fiber for distances up to 550m.
<b>P1SM10</b>	For use with Single-Mode Fiber for distances up to 10km.
<b>P1AB2K</b>	For use with Single Strand Single-Mode Fiber for distances up to 2km.
<b>P1GCE</b>	For use with CAT5e or better for distances up to 100m.

## Installation Instructions:

Wiring methods shall be in accordance with the National Electrical Code/NFPA 70/ANSI, and with all local codes and authorities having jurisdiction. All units should be installed by a trained service personnel.

### Mounting Instructions:

#### NetWaySP4BTB:

1. Mount board in the desired location/enclosure with hardware supplied.

**Note:** For proper earth ground connections on NetWaySP4BTB fasten metal spacers (provided) to threaded studs at indicated board mounting holes (shown on the right). This is recommended for better environmental immunity.

2. Connect external 48V-56V UL Listed ITE power source to terminal marked [+] and [-], carefully observing correct polarity (Fig. 2, pg. 6).

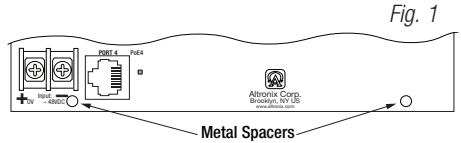

Fig. 1

#### NetWaySP4BTWPN/NetWaySP4BTWP/NetWaySP4BTWPX:

1. Remove backplane from enclosure prior to drilling. Do not discard hardware.

**Note:** Make sure that hardware will not interfere with components of the circuit board.

2. Mark and drill desired inlets on the enclosure to facilitate wiring. Maximum NEMA type 4X rated fittings to be used are 0.5". Follow manufacturer's specifications for the appropriate size opening.

**Note:** Inlets for conduit fittings should only be made on the bottom of the enclosure.

To facilitate wire entry utilize weather-tight NEMA rated connectors (supplied), bushings, and cable.

3. Clean out the inside of enclosure before remounting circuit boards/backplane.

4. **NetWaySP4BTWPN:** Connect external 48V-56V UL Listed ITE power source to terminal marked [+] and [-], carefully observing correct polarity (Fig. 2, pg. 6).

5. Mounting NEMA4/4X rated enclosure (Enclosure Dimensions, pg. 13-16):

**Wall mount:** Mount unit in desired location. Mark and drill holes to line up with the top and bottom hole of the enclosure flange. Secure enclosure with appropriate fasteners (e. g. screws and anchors; bolts and locking nuts, etc.) that are compatible with mounting surface and are of sufficient length/construction to ensure a secure mount (Fig. 6, pg. 10).

**Pole Mount:** Refer to Fig. 7 - 11, pg. 10.

6. Mount backplane in enclosure with hardware.

#### NetWaySP4BTX:

1. Mount unit in the desired location. Mark and predrill holes in the wall to line up with the top two keyholes in the enclosure. Install two (2) upper fasteners and screws in the wall with the screw heads protruding. Place the enclosure's upper keyholes over the two (2) upper screws; level and secure. Mark the position of the lower two (2) holes. Remove the enclosure. Drill the lower holes and install two fasteners. Place the enclosure's upper keyholes over the two (2) upper screws. Install the two (2) lower screws and make sure to tighten all screws (Enclosure Dimensions, pg. 10). Secure enclosure to earth ground.

#### NetWaySP4BTPL:

1. Mount backplane in the desired enclosure with hardware supplied (Backplane Dimensions, pg. 11).

### Power Connection:

#### For NetWaySP4BTWP, NetWaySP4BTWPX, NetWaySP4BTX, and NetWaySP4BTPL:

1. Secure cabinet to earth ground. Connect AC power from overcurrent protective device circuit breaker (20A @ 115VAC, 60Hz, 16A @ 230VAC, 50/60Hz) to the terminals marked [L, N] on power supply board (Fig. 3, pg. 7). Use 14AWG or larger for all power connections (Battery, DC output, AC input). Connect ground lug (⊕) to earth or green branch wire (12AWG min.).

**Keep power-limited wiring separate from non power-limited wiring by utilizing separate knockouts/inlets. Minimum 0.25" spacing must be provided.**

**CAUTION: Do not touch exposed metal parts. Shut branch circuit power before installing or servicing equipment. There are no user serviceable parts inside. Refer installation and servicing to qualified service personnel.**

## Input/Data Connections:

1. Connect structured cables from port marked [Port 1] to [Port 4] on NetWay unit to PoE compliant cameras/edge devices (Fig. 2, pg. 6).
2. Insert SFP module into port(s) marked [SFP], then connect cable to the SFP module on NetWaySP4BTB to the corresponding input of an SFP switch (Fig. 2, pg. 6).

## Battery Backup (if desired):

### NetWaySP4BTWP/ NetWaySP4BTWPX/NetWaySP4BTX/NetWaySP4BTPL:

1. Connect two (2) 12VDC batteries wired in series or one (1) 24V battery to terminals marked [- BAT +] (Fig. 3, pg. 7), carefully observing polarity. When use of stand-by batteries is desired, they can be LiFePO<sub>4</sub> (lithium iron phosphate), lead acid or gel type.

**Note:** When batteries are not used, a loss of AC will result in the loss of output voltage.

**Note:** When using two 12V LiFePO<sub>4</sub> (lithium iron phosphate) batteries, check with manufacturer specifications that batteries can be connected in series.

**For outdoor battery backup, battery enclosure must have sufficient ventilation. Use Altronix Vent2 kit.**

## Security:

Please ensure that the cover is secured with:

Key lock and screws for **NetWaySP4BTX**,

Latches and optional Altronix Lock1WP for **NetWaySP4BTWP(X)** and **NetWaySP4BTWPN**.

## Technical Specifications:

Parameter	Description		
Number of Ports	Four (4) 10/100/1000 Mbps Ethernet ports rated at 90W each. IEEE 802.3af, 802.3at, 802.3bt compliant. Two (2) Gigabit SFP Ports.		
Input Power Requirements	<b>NetWaySP4BTWP/NetWaySP4BTWP/NetWaySP4BTPL/NetWaySP4BTX:</b> 115VAC, 60Hz, 1.8A or 230VAC, 50/60Hz, 1A. <b>NetWaySP4BTB/NetWaySP4BTWPN:</b> 48-56V UL Listed ITE power supply.		
Environmental Conditions	Operating Ambient Temperature: <b>240W:</b> - 40°C to 55°C (- 40°F to 131°F) <b>180W:</b> - 40°C to 65°C (- 40°F to 149°F) <b>150W:</b> - 40°C to 75°C (- 40°F to 167°F) Relative Humidity: 85%, +/- 5% Storage Temperature: - 30°C to 85°C (- 22°F to 185°F) Operating Altitude: - 304.8 to 2,000m		
Weights (approx.)	<b>Model</b>	<b>Product Weight</b>	<b>Shipping Weight</b>
	NetWaySP4BTWP	10.5 lb. (4.76 kg)	11.9 lb. (5.4 kg)
	NetWaySP4BTWPX	15 lb. (6.8 kg)	17.5 lb. (7.9kg)
	NetWaySP4BTWPN	9.5 lb. (4.3 kg)	10.9 lb. (4.9 kg)
	NetWaySP4X	6.85 lb. (3.11 kg)	7.75 lb. (3.51 kg)
	NetWaySP4PL	2.6 lb. (1.18 kg)	4.0 lb. (1.81kg)
	NetWaySP4BTB	0.4 lb. (0.18 kg)	0.75 lb. (0.34 kg)

Fig. 2 - NetWaySP4BTB/NetWaySP4BTWPN – Typical Application with Composite Cable

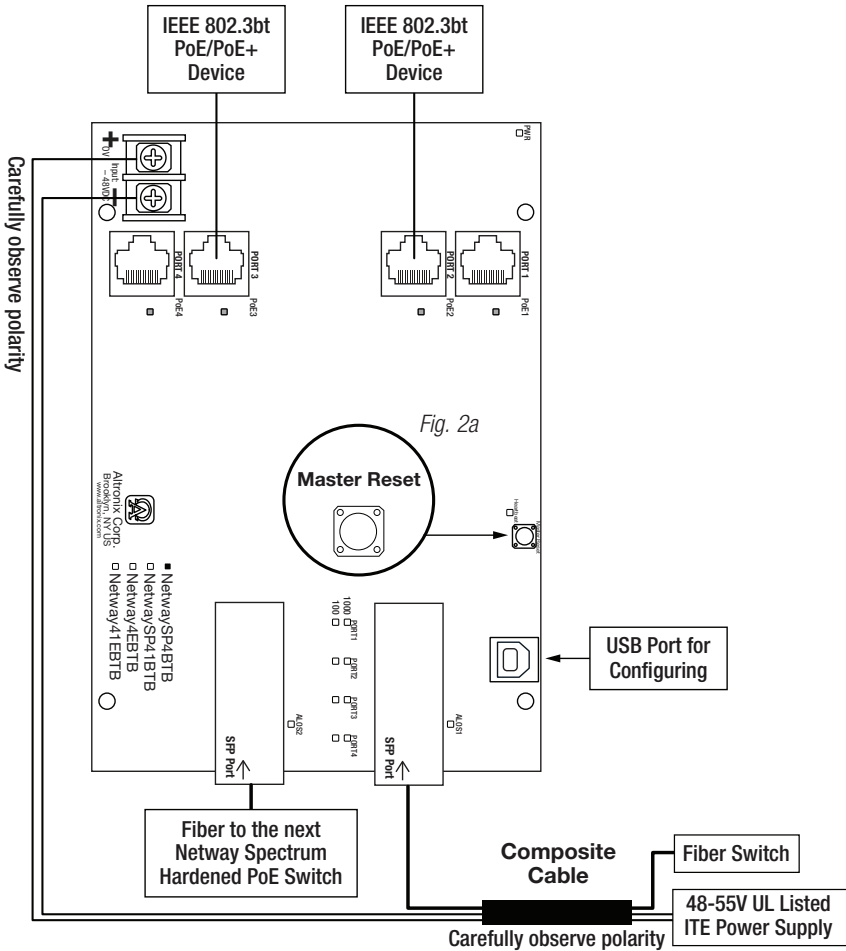

### Powering Cable Distance Chart

Power Requirements	Power Cabling AWG	Maximum Distance (ft./m)
15W	12/2	11,162' / 3,403m
30W	12/2	5,581' / 1,702m
45W	12/2	3,767' / 1,148m
60W	12/2	2,739' / 835m
75W	12/2	2,249' / 686m
90W	12/2	1,872' / 571m
105W	12/2	1,607' / 490m
120W	12/2	1,408' / 429m
180W	12/2	

Power Requirements	Power Cabling AWG	Maximum Distance (ft./m)
15W	16/2	4,415' / 1,346m
30W	16/2	2,207' / 673m
45W	16/2	1,490' / 454m
60W	16/2	1,083' / 330m
75W	16/2	889' / 271m
90W	16/2	740' / 226m
105W	16/2	635' / 194m
120W	16/2	557' / 170m
180W	16/2	

Estimated distances based on starting voltage of 56VDC and accounts for a 10 volt drop.  
 All distances are per IEEE 802.3at standard for device power requirements of minimum 44VDC and leave an approximate 2 volts for safety and flexibility.

**Fig. 3 - NetWaySP4BTX/NetWaySP4BTWP/NetWaySP4BTWPX/NetWaySP4BL – Typical Application with Factory Installed Power Supply**

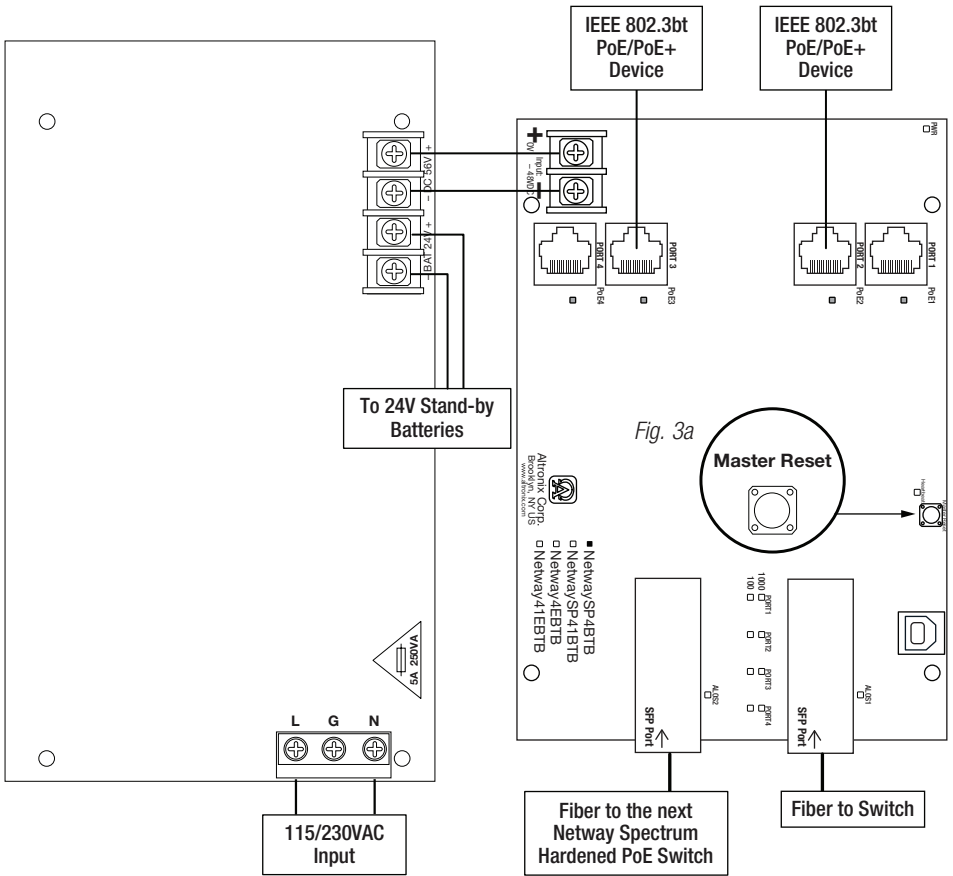

## Configuring Unit for Network Connection:

Visit [altronix.com](http://altronix.com) for the latest firmware and installation instructions

### VLans

VLans (Virtual Local Area Networks) are a subnetwork that allow for the grouping together of devices for improved network traffic as well as providing higher security by allowing greater control over which devices have access to each other. It is important to plan how you will setup your devices for each vLan.

### Configuring vLan on the Altronix NetwaySP4BT Series Layer 2 Switch:

1. Ensure Laptop or PC being used to program the vLan settings is on a port that will be assigned to your first vLan configuration. By default the management portion of the software is assigned to vLan-1, **CAUTION:** Changing VID=1, the industry standard VLAN HOST address to any other VID address should be done with caution and performed only locally, since the change will drop the original HOST connection. Local access then facilitates a physical reconnection to respective port.  
**Note:** Only this vLan network allows access to IP management.
2. In Network Section click on vLan Tab.
3. Click Add vLan.
4. Enter a name for the vLan.
5. Enter a vLan ID, i.e. 10, 20, etc. Ensure this vLan ID is associated with a vLan setup on the main switch and that your Laptop or PC being used for programming is on this same ID.  
**Note:** vLan ID could be any value 2-4094.
6. Assign vLan QOS (Quality of Service) priority. 0 = Lowest and 7 = Highest
7. Pick a Trunk port (Tagged Ports). Trunk ports are typically the main connection for network traffic for each group. They are usually connected to a network switch, WAPs, etc.
8. Pick the Access port(s) (Untagged Ports) associated with the vLan. Access Ports are typically used for Cameras, etc. If programming locally, ensure your laptop or PC is connected to one of these ports.
9. Save Configuration.
10. Repeat steps 2 - 9 to add another vLan.  
If unit is accidentally programmed incorrectly and you cannot get into the NetwaySP4BT series programming, physically moving ports of your PC connected to the main switch to a correct port (when being programmed remotely), or, as a last resort, completing a factory reset locally and reprogramming the unit.
11. **Advanced Port Settings:**  
Unknown VID Packet Forwarding Configuration:  
On ingress unknown VID, Forward to a fixed set of ports. By default no forwarding is set.  
Configuration on Ingress Untagged Traffic:  
Trunk Port action for ingress UNTAGGED packets. By default do not drop packets.  
Keep Tag on Egress:  
Select if you want ACCESS Port to keep the vLan tag when sending egress packets.  
By default tags are stripped.  
Preferred VLAN Forwarding:  
For ACCESS Ports that belong to more than one vLan. Select preferred vLan to forward UNTAGGED ingress packets. By default preferred vLan is the last vLan created.

### Factory Reset Option:

1. Power the unit down. Allow approximately 30 seconds for the unit to power down completely.
2. Depress Factory Reset button on NetWaySP4BTB while reapplying power to the unit (Fig. 2a, 3a, pg. 6, 7; Fig. 4, pg. 8). Continue holding the button until the LEDs on board go through the start up cycle, then release the button.
3. The unit returns to the original factory settings.

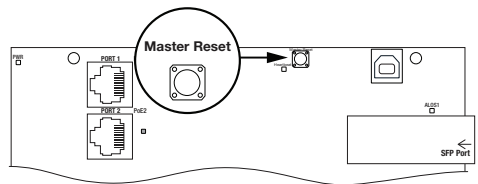
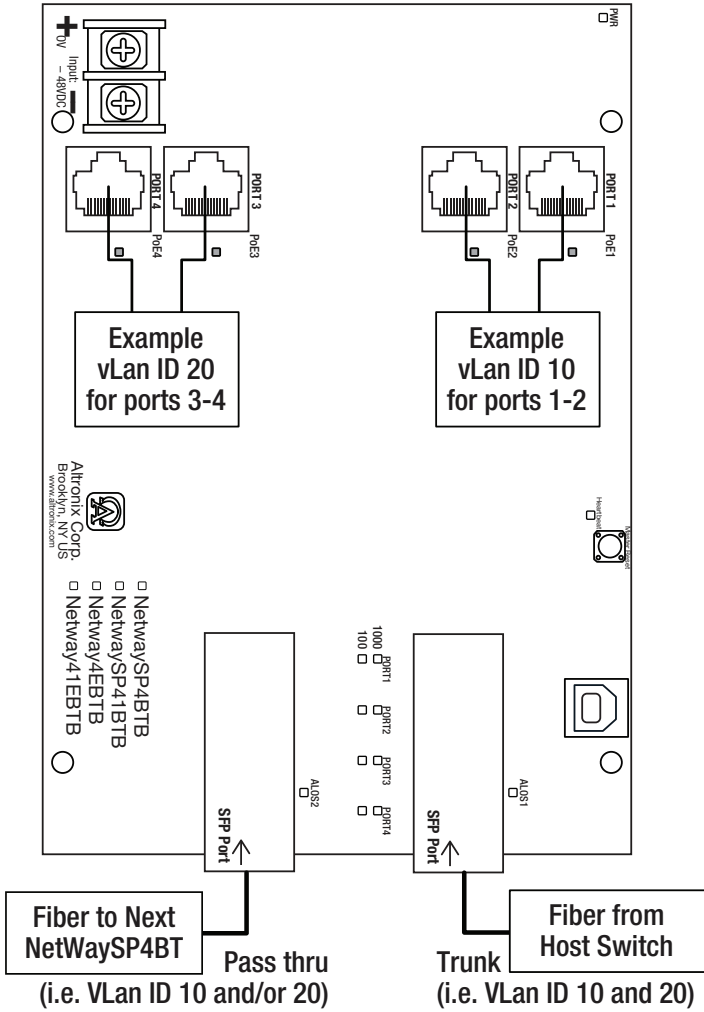

Fig. 4



Fig. 5 - Typical VLAN Setup:



## Wall Mount Installation:

- 1- Place unit at desired location and secure with mounting screws (not included) (Fig. 6, pg. 10).

Fig. 6

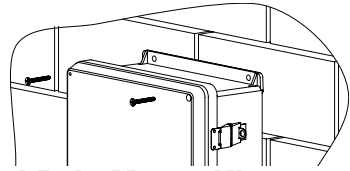

## Pole Mounting Using Optional Pole Mount Kit PMK1 (NetWaySP4BTWP) or PMK2 (NetWaySP4BTWPX):

This installation should be made by qualified service personnel. This product contains no serviceable parts. PMK1 and PMK2 outdoor pole mount kits are designed to simplify the installation of Altronix outdoor rated power supplies and accessories housed in models WP1, WP2, WP3 and WP4 NEMA rated enclosures. PMK1 and PMK2 can be mounted on 2" to 8" (50.8mm to 203.2mm) diameter round or 5" (127mm) square poles. Brackets are designed for use with the Wormgear Quick Release Straps (two included).

1. Thread one (1) wormgear quick release strap through the slots on the back of a mounting bracket (Fig. 7, pg. 10).
2. Once the desired height of the top Pole Mount bracket is achieved, tighten the straps down by sliding open end of the strap through the locking mechanism on the strap, then tighten the screw with flat head screwdriver or 5/16" hex socket driver (Fig. 8, pg. 10 and Fig. 10, pg. 10).

Fig. 7

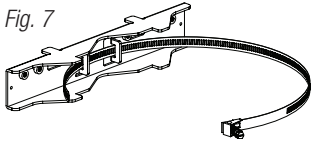

Fig. 8

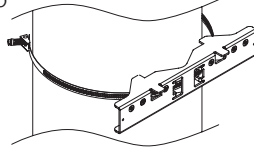
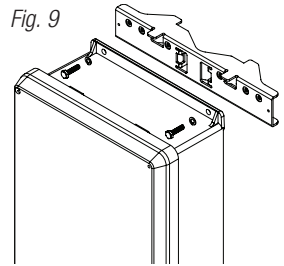

Fig. 9



3. Attach the bottom bracket to the enclosure by inserting bolts through the flange of the enclosure and into the bracket, tightening bolts with a 7/16" hex socket (Fig. 9, pg. 10).
4. Thread the second wormgear quick release strap through the slots on the back of the bottom mounting bracket (Fig. 10, pg. 10).
5. Mount enclosure onto the top bracket by inserting bolts through flange of the enclosure and into the bracket, tightening bolts with a 7/16" hex socket (Fig. 8, pg. 10).
6. Tighten the straps of the bottom bracket down by sliding the open end of the strap through the locking mechanism on the strap, then tighten screw with flat head screwdriver or 5/16" hex socket driver (Fig. 8, pg. 10).
7. Clip excess straps.

Fig. 10

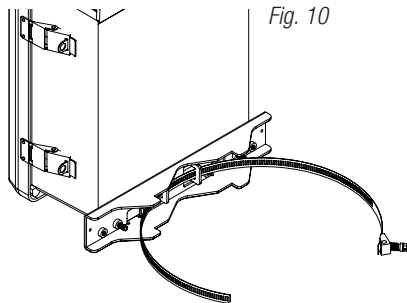

Fig. 11  
2" to 8" (50.8mm to 203.2mm)  
diameter round pole

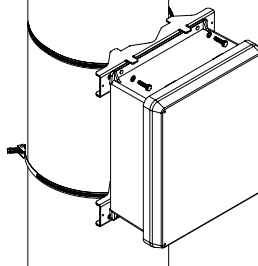
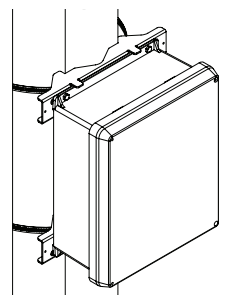

Fig. 11a  
5" (127mm) square pole



## Notes:

## Notes:

# NetWaySP4BTX

## Mechanical Drawing and Dimensions (H x W x D approx.):

13.5" x 13" x 3.25" (342.9mm x 330.2mm x 82.6mm)

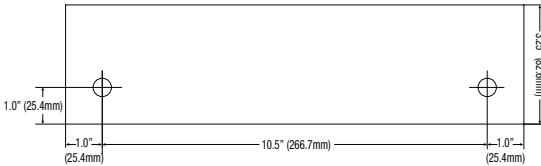
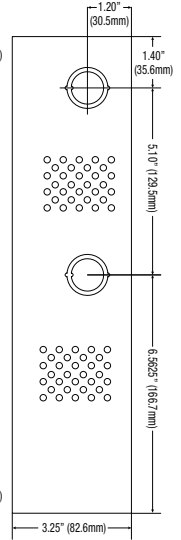
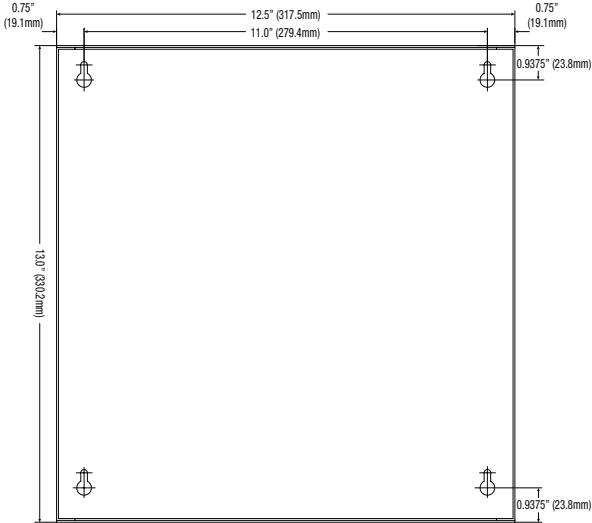
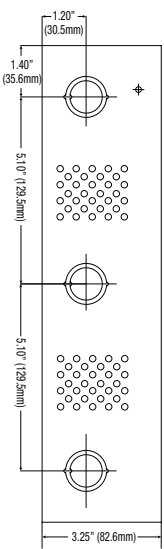
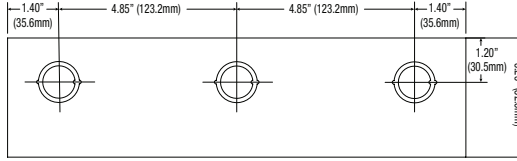

# NetWaySP4BTPL

## Mechanical Drawing and Dimensions (H x W x D approx.):

10.75" x 8.875" x 2.375" (273.1mm x 225.4mm x 60.3mm)

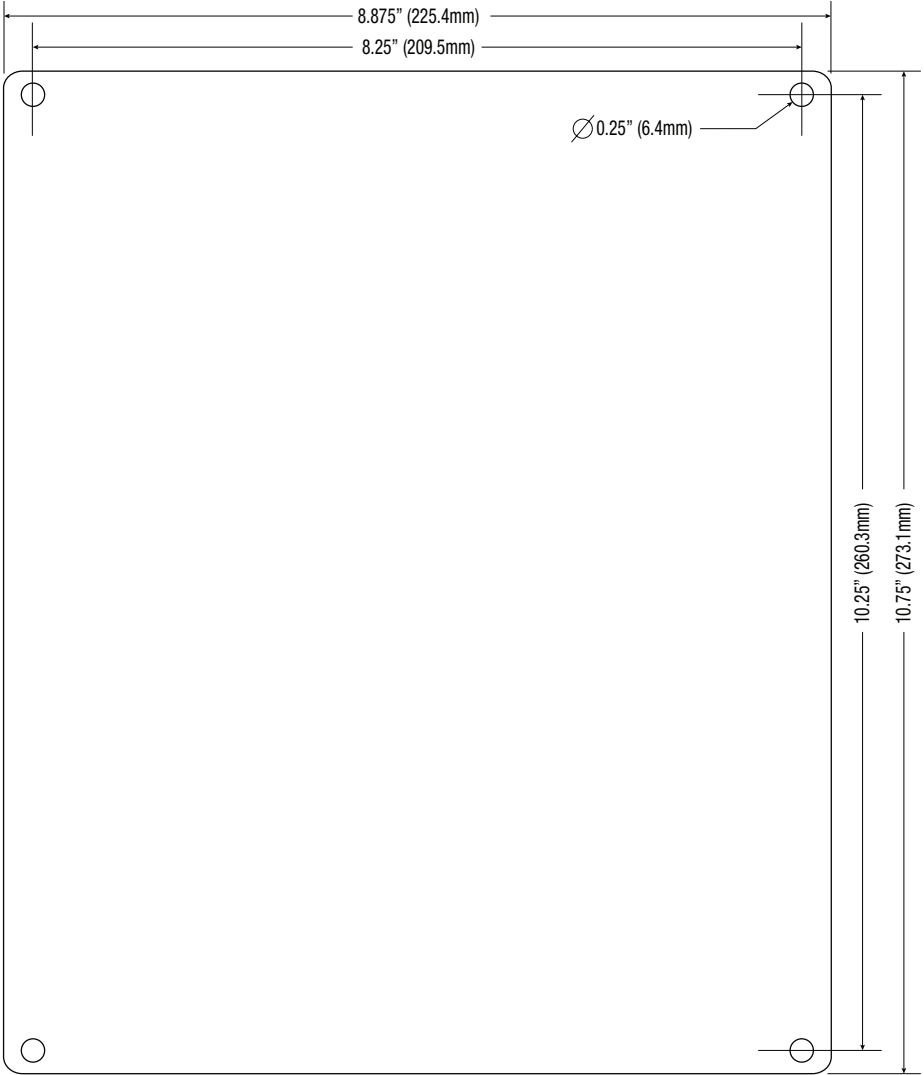

# NetWaySP4BTWP and NetWaySP4BTWPN Mechanical Drawing and Dimensions (H x W x D approx.):

13.31" x 11.31" x 5.59" (338.1mm x 287.3mm x 142mm)

**FRONT VIEW**

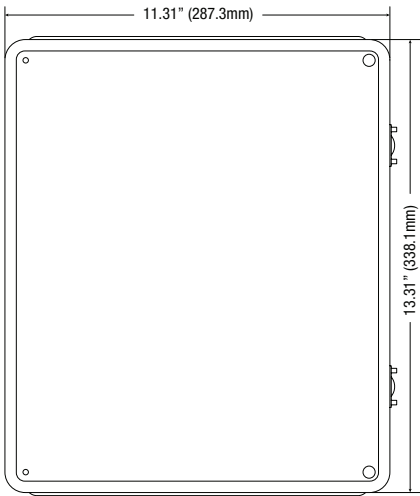

**RIGHT SIDE VIEW**

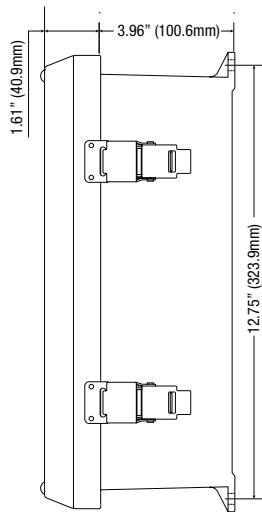

**FRONT VIEW COVER REMOVED**

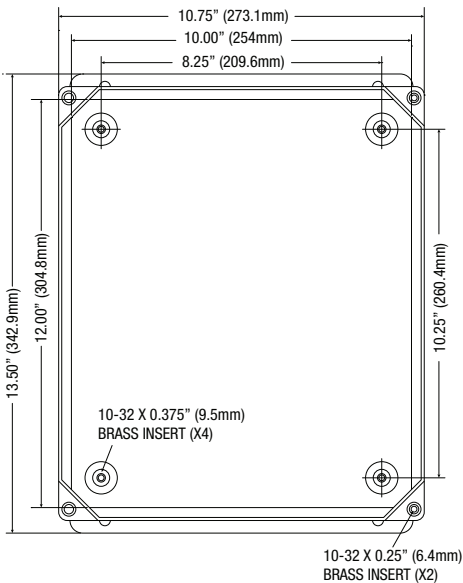

**END VIEW**

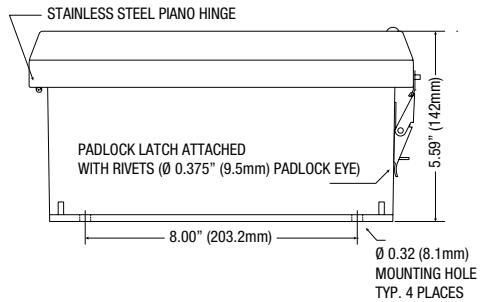

# NetWaySP4BTWPX

## Mechanical Drawing and Dimensions (H x W x D approx.):

17.53" x 15.3" x 6.67" (445.3mm x 388.6mm x 169.4mm)

**FRONT VIEW**

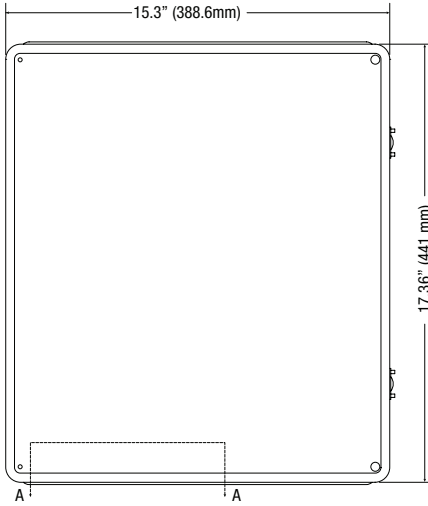

**RIGHT SIDE VIEW**

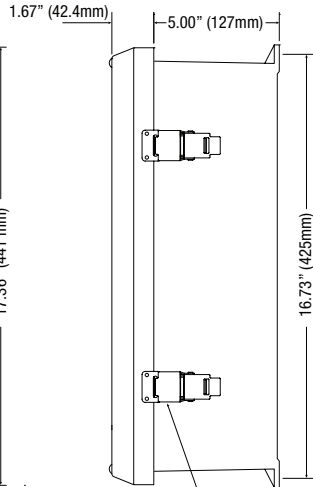

316 STAINLESS STEEL PADLOCK LATCH  
ATTACHED WITH RIVETS. Ø 0.375 PADLOCK EYE

**FRONT VIEW COVER REMOVED**

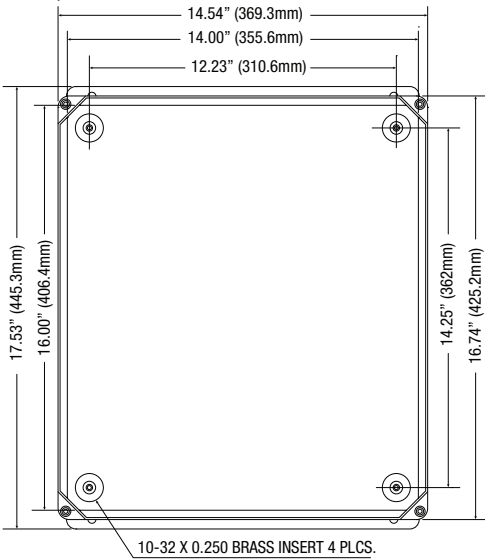

10-32 X 0.250 BRASS INSERT 4 PLCS.

**SECTION A-A**

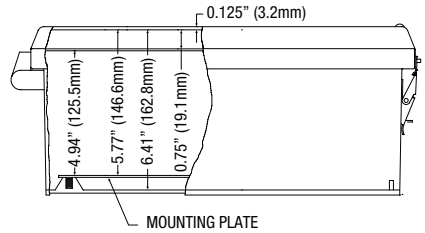

MOUNTING PLATE

**END VIEW**

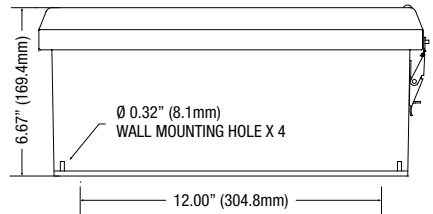

Ø 0.32" (8.1mm)  
WALL MOUNTING HOLE X 4

Altronix is not responsible for any typographical errors.

140 58th Street, Brooklyn, New York 11220 USA | phone: 718-567-8181 | fax: 718-567-9056  
 website: [www.altronix.com](http://www.altronix.com) | e-mail: [info@altronix.com](mailto:info@altronix.com) | Lifetime Warranty  
 IINetWaySP4BT Series H29Y

